







Wireless EnOcean repeater

Transmit signals over a longer distance or around obstructions.

Our wireless smart repeater is a cost-effective way to increase the range of your smart devices, allowing them to transmit data over a larger distance or where obstructions occur. Depending on the configuration and the building, repeaters can extend the EnOcean sensors' range from 30m up to 90m.

Features

-  Extends EnOcean range up to 90m, depending on the configuration of a building
-  Select which sensors to repeat, reducing interference and ensuring clear radio signals
-  Fitted with external antenna
-  Powered via USB
-  Repeater: Function as a level 1 or a level and 2
-  Radio link test mode



Integrating sensor data

Our smart gateway receives near real-time data from all sensors within range, converts the raw data into an easy-to-use JSON format, then publishes it using MQTT protocol. Data can be sent - via Ethernet, LTE (4G) or WiFi - to any local or cloud MQTT broker; securely to IBM Watson IoT, Microsoft Azure IoT Hub or AWS IoT Core; directly into Google Sheets; or to a Node-RED application.

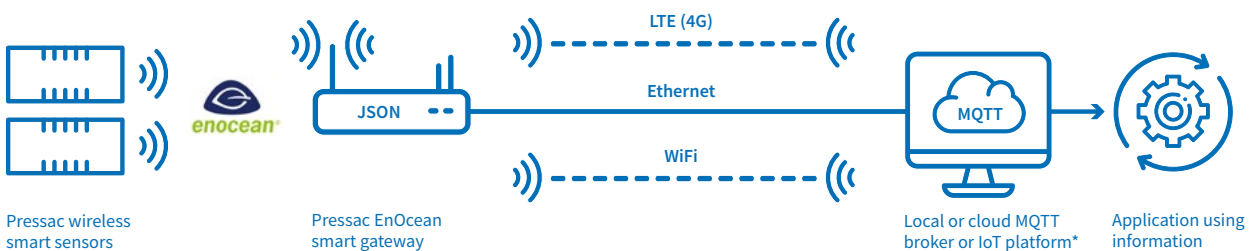

*Ready-made connections with:



Technical specification

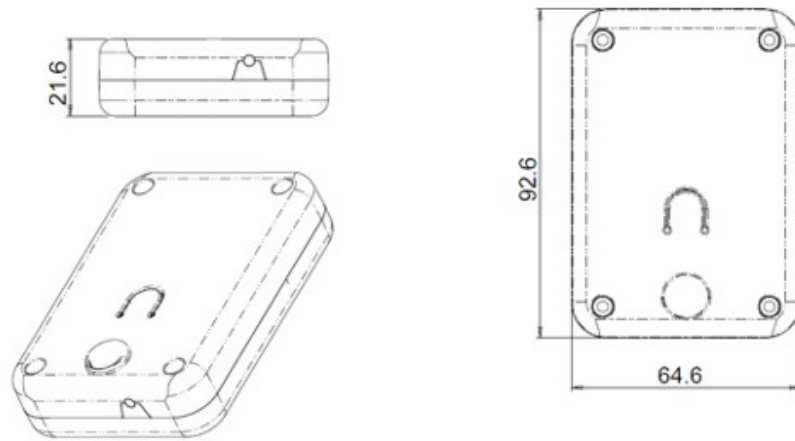

Power specification	Power supply: USB 5v DC powered. USB adaptor provided Connecting power: RJ45 / DC Jack
Wireless specification	Protocol: EnOcean Radio frequency: <ul style="list-style-type: none"> • 868 MHz for Europe and other countries adopting RED • 902 MHz for USA (FCC specification) and Canada (IC specification) Security: repeats both secure and un-secure telegrams Interoperability: EnOcean certification 3.0
Enclosure specification	Material: ABS plastic IP rating: IP3X Dimensions: 93 x 65 x 28 mm (approx) Antenna connector: RP SMA
Installation	Fixing: adhesive pads or screws provided Operating temperature: 0°C to 50°C Storage temperature: -20°C to +55°C Environment: indoor
Compliance	CE approved, RoHS compliant, FCC compliant
Part number	REPEATER_[868_UK]-[902_US]_[S]-[B]

